

TSHA2101CQ

Integrated AMR (Anisotropic Magnetoresistance) Magnetic Sensor

The TSHA2101CQ is an AMR (Anisotropic Magnetoresistance) based magnetic sensor, when combined with a magnet, it becomes a non-contact switch with low power consumption, high sensitivity and high reliability device.

It is produced with SIP (System in Package) technology, which combines an AMR sensor & ASIC in one IC. It supports both 2-wire & 3-wire applications for cylinder position detection.



Official Website



X



LinkedIn

For more inquiries: marketing@ts.com.tw

© 2024 TAIWAN SEMICONDUCTOR, CO., LTD. ALL RIGHTS RESERVED.

IC & PACKAGE

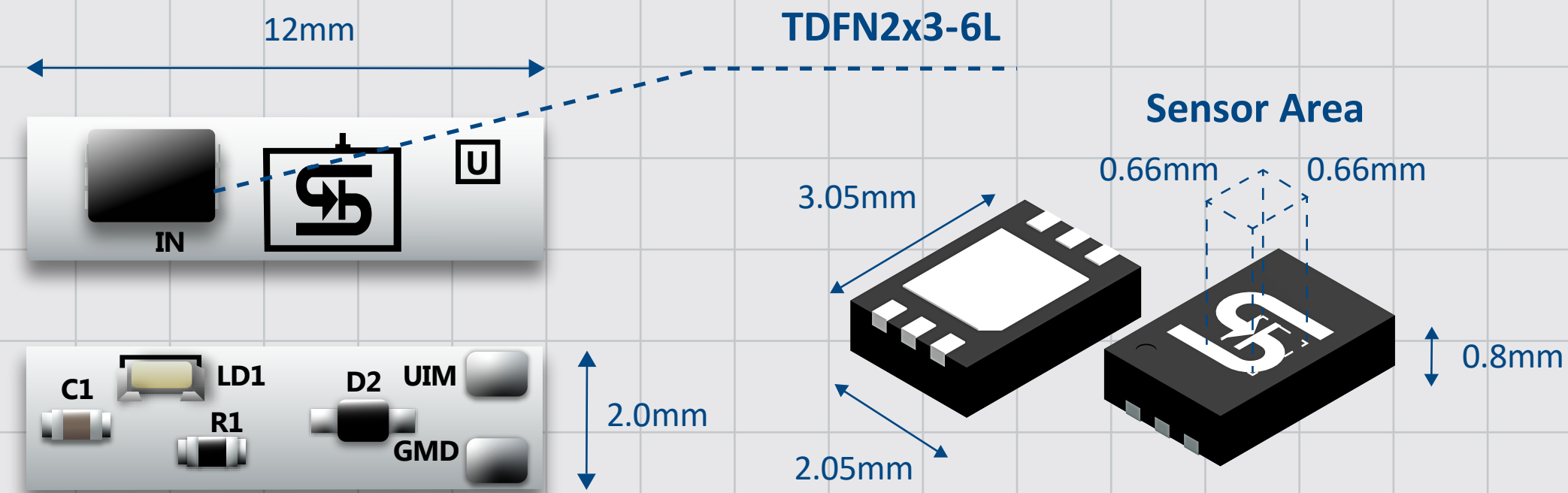

FEATURES

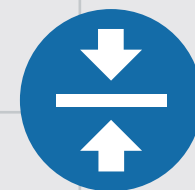

PCB SPACE SAVINGS



OPERATING TEMPERATURE
-40°C ~ 105°C



OUTPUT OVER-CURRENT
PROTECTION



-30V REVERSE POWER
SUPPLY PROTECTION



HIGH INTEGRATED SOLUTION

APPLICATION

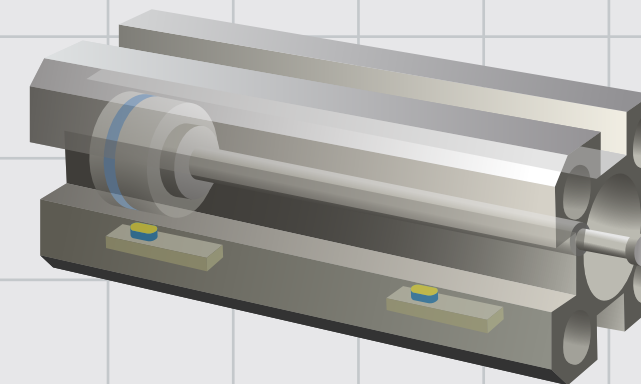

A horizontal magnetic field parallel to the electrode of the package can be detected by an arbitrary polarity.

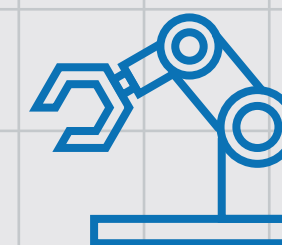

FACTORY
AUTOMATION

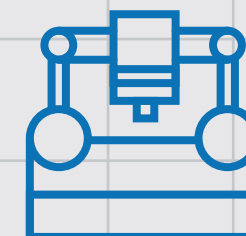

ROBOTICS

DETECTION OF SWITCHING FUNCTION

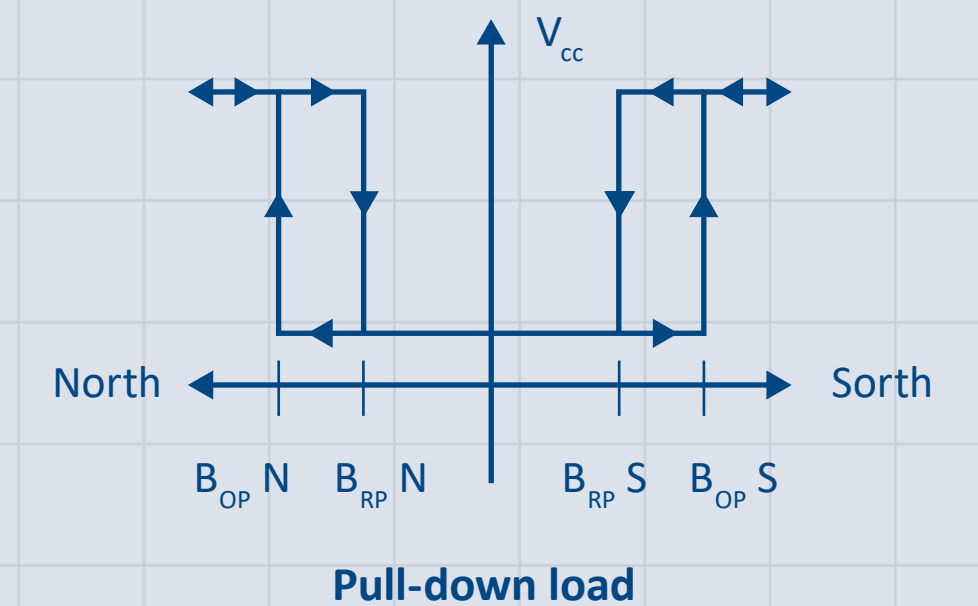
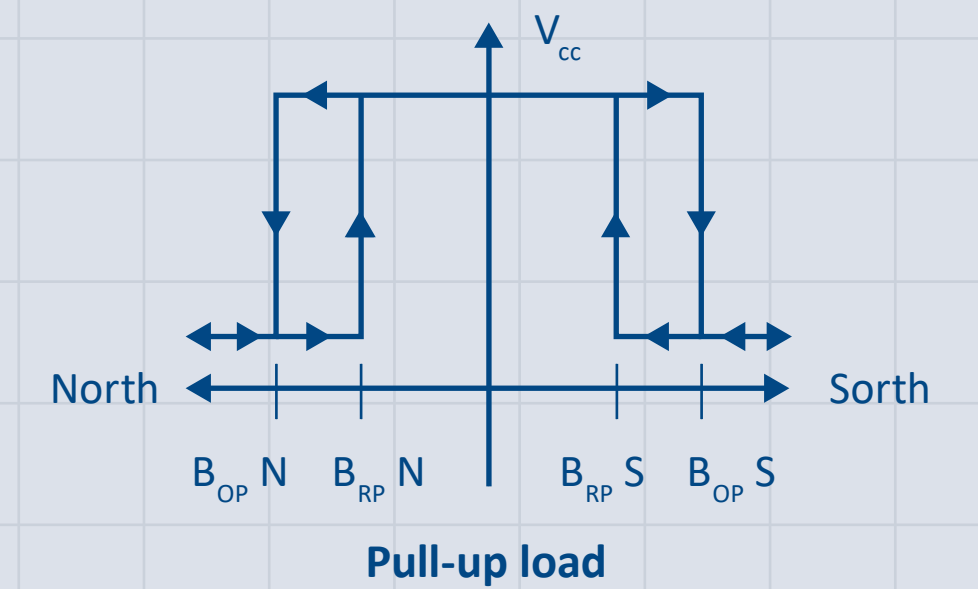

TSHA2101CQ can be used in both pull-up load and pull-down load applications.



TAIWAN
SEMICONDUCTOR

www.taiwansemi.com