

SURFACE MOUNT PACKAGING PACKED PER EIA/JEDEC STANDARD RS-481

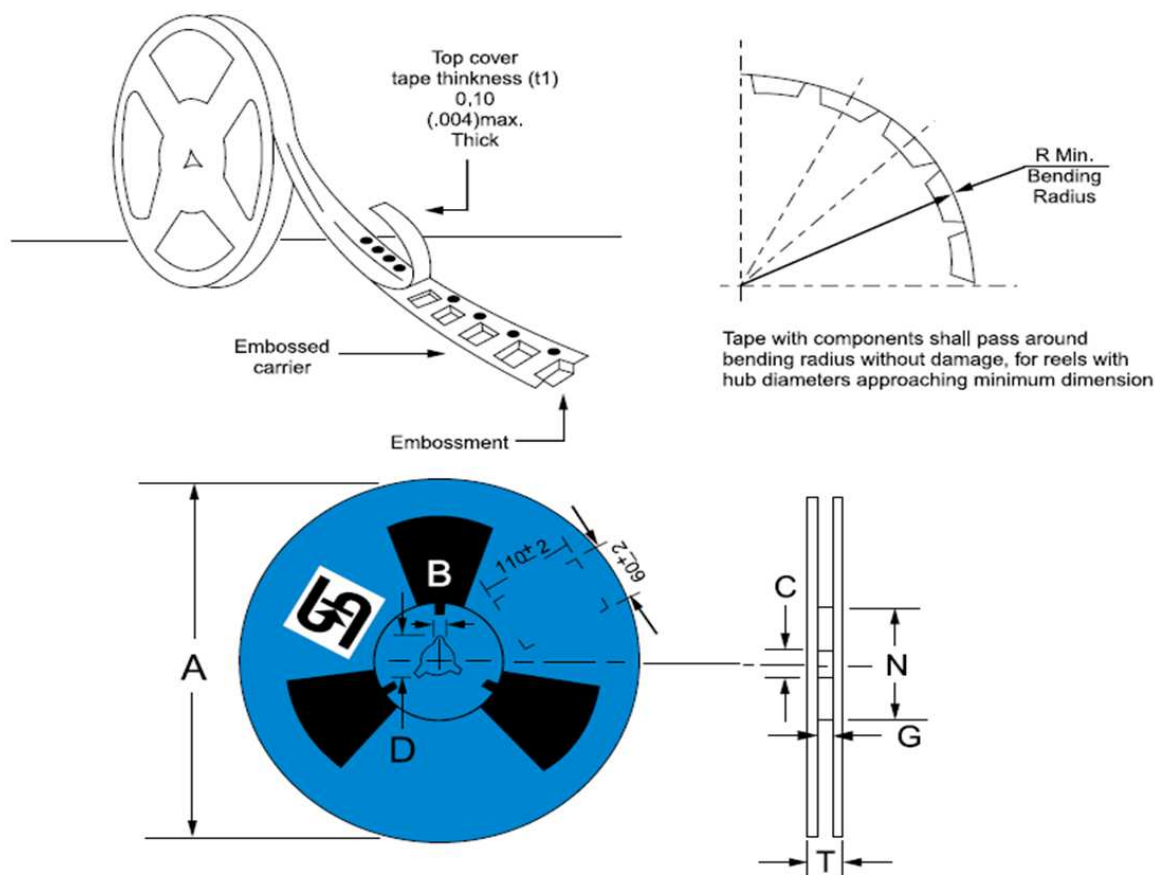

Reel size	Tape size (mm)	Case	A max	B (mm)	C (mm)	D min	N (mm)	G (mm)	T max
7"	12	SMAF	178±2	19±0.4	13+0.5/-0.2	-	62±1.0	12.2+0.8/-0	16.8±2.0
7"	8	Micro-SMA	178±2	2.2±0.4	13.3+0.5/-0.2	-	60±1.0	9.07+0.8/-0	11.9
7"	8	Sub SMA/SOD-123HE/ SOD-123FL/SOD-123W	178±2	1.9±0.4	13+0.5/-0.2	21	62±1.0	8.2+0.8/-0	10.6
7"	12	Sub SMA/SMA/SMB /MBS/ABS	178±2	1.9±0.4	13+0.5/-0.2	21	62±1.0	12.2+0.8/-0	14.6
7"	16	SMC	178±2	1.9±0.4	13+0.5/-0.2	21	62±1.0	16.2+0.8/-0	18.4
7"	8	Mini-MELF	178±2	1.5min ±0.4	13+0.5/-0.2	20.2	55±1.0	8.4+0.8/-0	14.4
7"	12	Mini-MELF	178±2	1.5min ±0.4	13+0.5/-0.2	20.2	60±1.0	12.4+0.8/-0	18.4
7"	8	SOT-23/SOT-25 /SOT-26	178±1	-	13+0.5/-0.2	-	60±0.5	9+1.5/-0	11+1.5/-0
7"	12	DFN22 / DFN33	178±1	-	13+0.5/-0.2	-	-	14.4	-
7"	12	SOT-89 / SOT-89-5L	178±1	-	13+0.5/-0.2	-	60±0.5	13+0.15/-0	16+0.15/-0
7"	8	SOD-523F	177.7	2.2	13.1	22	56	9.3	11
7"	8	SOD-723F	177.7	2.2	13.1	22	56	9.3	11
7"	8	DFN1006 (0402)	178±2	-	13±1	-	54.4±1	9.50±1	12.30±1
7"	8	DFN1006L	177.7	2.2	13.1	22	56	9.3	11

SURFACE MOUNT PACKAGING PACKED PER EIA/JEDEC STANDARD RS-481

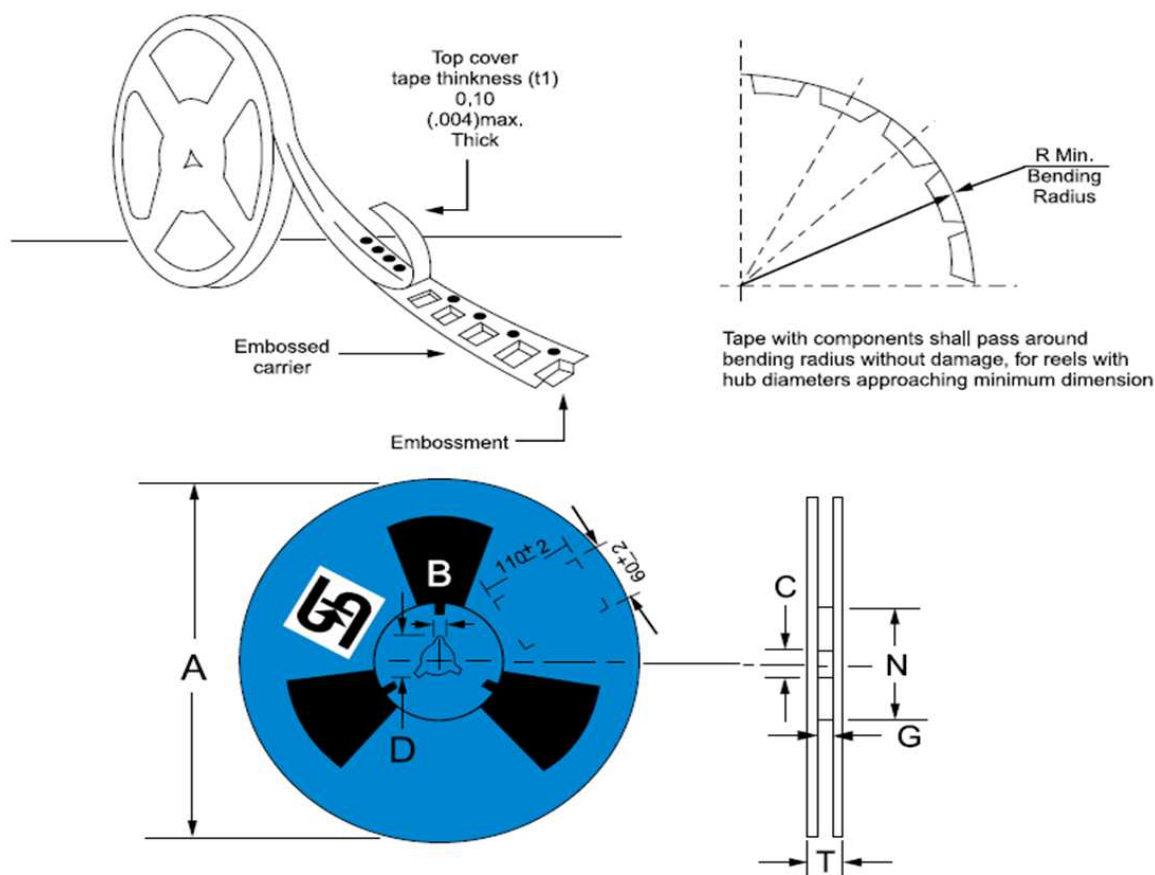

Reel size	Tape size (mm)	Case	A max	B (mm)	C (mm)	D min	N (mm)	G (mm)	T max
13"	8	Sub SMA/SOD-123W	330	2±0.5	13±0.5	20.2	100±0.5 max	8.5 +2.0/-0	14.5
13"	8	SOD-123FL	330	2±0.5	13±0.5	20.2	75±0.5	8.5 +2.0/-0	14.5
13"	12	SMAF/SMBF	330	2±0.5	13±0.5	20.2	75±0.5	12.4+2.0/-0	18.4
13"	12	SMA/SMB/ MBS/ABS/Sub SMA	330	2±0.5	13±0.5	20.2	100±0.5 max	12.4+2.0/-0	18.4
13"	16	SMC/DBLS/DPAK	330	2±0.5	13±0.5	20.2	100±0.5 max	16.4+2.0/-0	22.4
13"	24	TO-263AB (D ² -PAK)	330	2±0.5	13±0.5	20.2	100±0.5 max	24.4+2.0/-0	30.4
13"	12	MELF	330	1.5±0.5	13±0.2	20.2	50±0.5	12.2+2.0/-0	18.4
13"	12	Mini-MELF	330	1.5min ±0.5	13±0.5	-	100±0.5	8.4+2.0/-0	14.4
13"	8	Mini-MELF	330	1.5min ±0.5	13±0.5	-	100±0.5	12.4+2.0/-0	18.4
13"	8	SOT-23	330±1	-	13+0.5/-0.2	-	62±1.5	8.4±0.2	-
13"	12	TSSOP-8	330±1	-	13+0.5/-0.2	-	-	12.4±0.2	-
13"	12	SOP-8 / MSOP-8 / SOT-223 / DFN33	330±1	-	13+0.5/-0.2	-	97±0.1	13+0.15/-0	17.4+0.15/-0
13"	16	SOP-14 / SOP-16 / TO-252	330±1	-	13+0.5/-0.2	-	62±1.5	16.4±0.2	-
13"	24	TO-263 / TO-263-5L	330±1	-	13+0.5/-0.2	-	62±1.5	24±0.2	-
13"	16	YBS	330	3	14±0.5	18.5±0.5	100	17±0.3	20

Embossed Carrier Dimensions

Micro-SMA /Sub SMA /SMA /SMB /SMC /MELF /Mini-MELF/
SOD-123W /SOD-123HE /SOD-128

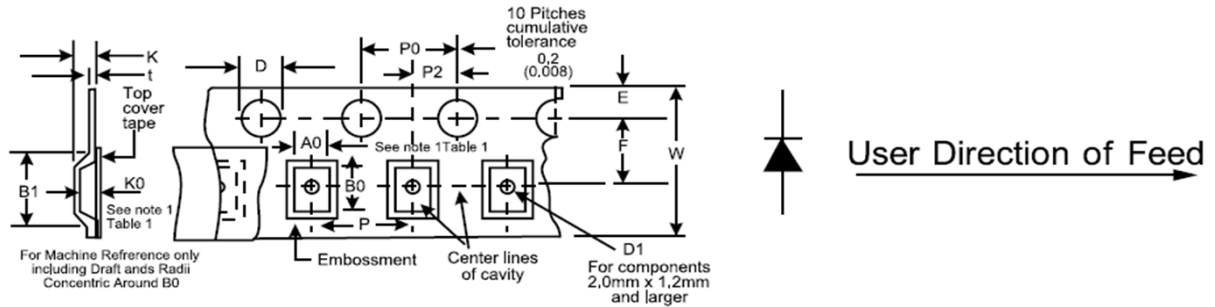

MBS/ABS/DBLS

DPAK/D²PAK

PDFN56/PDFN33
/SOP-8

TDFN 2x2

SOT-26

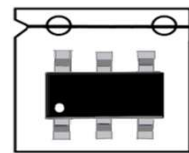
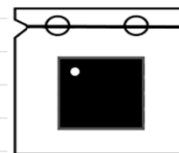
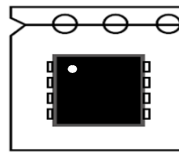
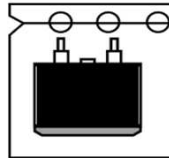
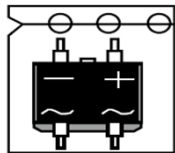

Note 1 : Every second pocket in tape populated.

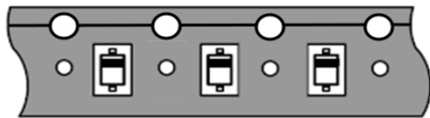

EMBOSSED TAPE

ALL DIMENSION IN MILLIMETERS

Tape Size	D	E	P0	t Max.	A0/B0/K0	P2	CONSTANT DIMENSIONS
8mm	1.55 +/-0.05	1.75 +/-0.10	4 ±0.20	0.369	0.05~16.2	2 +/- 0.1	
12mm							
16mm							
24mm							

Product Type	Tape size (mm)	B1 max.	D1 min.	F	K max.	W	P	Note
Micro SMA	8	2.75±0.05	05±0.05	3.5±0.05	1	8+0.3,-0.1	4±0.1	
SMAF	12	5.33±0.1	-	5.05±0.05	2.46	12±0.2	4±0.1	
SMBF	12	5.75±0.1	1.55±0.05	5.5±0.1	1.4±0.1	12.0±0.1	8±0.1	
SOD-128	12	-	1.5+0.25,-0	5.5±0.05	1.25±0.1	12+0.3,-0.1	4±0.1	
Sub SMA/SOD-123HE/SOD-123W	8	4.6	0.95	3.5±0.05	1.52	8+0.3,-0.1	4±0.1	
Sub SMA	12	8.2	0.95	5.5±0.05	1.52	12+0.3,-0.1	4±0.1	
SMA	12	8.2	1.5	5.5±0.05	3	12+0.3,-0.1	4±0.1	
SMB	12	8.2	1.5	5.5±0.05	2.77	12+0.3,-0.1	8±0.1	
SMPC4.6 / SMPC4.0	12	8.2	1.5	5.5±0.05	1.6	12+0.3,-0.1	8±0.1	
PDFN56	12	8.2	1.5	5.5±0.05	1.6	12+0.3,-0.1	8±0.1	
ABS	12	-	1.4	5.5±0.05	1.7	12+0.3,-0.1	8±0.1	
MBS	12	8.2	1.5	5.5±0.05	3.05	12+0.3,-0.1	8±0.1	
SMC	16	12.1	1.5	7.5±0.1	2.64	16+0.3,-0.1	8±0.1	
DBLS	16	12.1	1.5	7.5±0.1	3.91	16+0.3,-0.1	12±0.1	
DPAK	16	10.4±0.1	-	4±0.1	2.5±0.1	16±0.3	8±0.1	
D2PAK	24	20.1	1.5	11.5±0.1	5.31	24+0.3,-0.1	16+/-0.1	
SOD-123FL	8	3.95±0.1	1.00±0.25	3.5±0.05	1.25±0.1	8+2.0,-0	4±0.1	
YBS	16	8.6±0.05	1.55±0.05	7.5±0.1	1.82±0.05	16±0.1	12±0.05	

Embossed Carrier Dimensions

Micro-SMA /Sub SMA /SMA /SMB /SMC /MELF /Mini-MELF/
SOD-123W /SOD-123HE /SOD-128

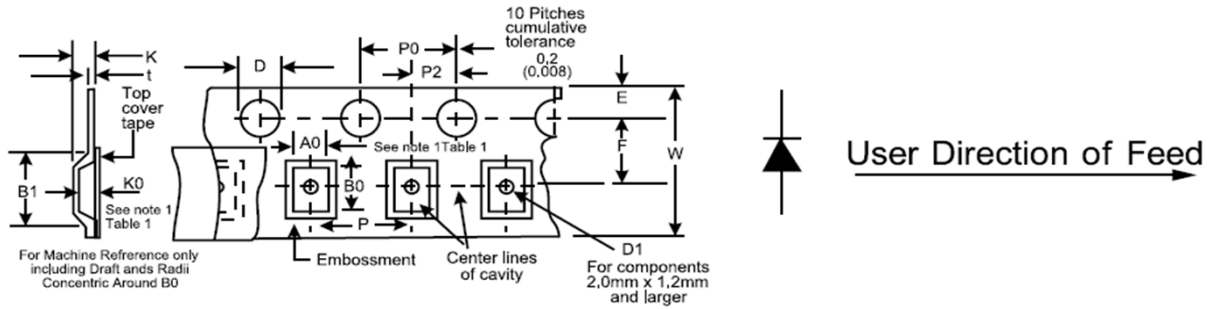

MBS/ABS/DBLS

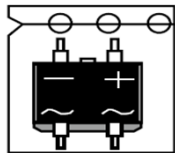

DPAK/D²PAK

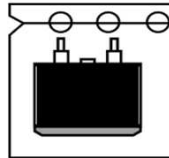

PDFN56/PDFN33
/SOP-8

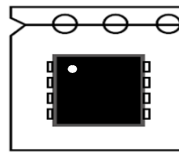

TDFN 2x2

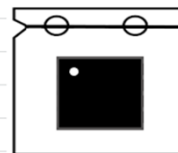

SOT-26

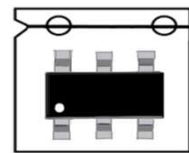

Note 1 : Every second pocket in tape populated.

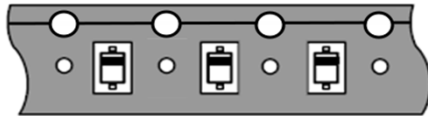

EMBOSSED TAPE

ALL DIMENSION IN MILLIMETERS

Tape Size	D	E	P0	t Max.	A0/B0/K0	P2	CONSTANT DIMENSIONS
8mm							
12mm	1.55	1.75	4	0.369	0.05~16.2	2	
16mm	+/-0.05	+/-0.10	±0.20			+/- 0.1	
24mm							

Product Type	Tape size (mm)	B1 max.	D1 min.	F	K max.	W	P	Note
SOT-23/SOT-25/SOT-26	8	-	-	-	-	8±0.3	4±0.2	
DFN 22/ DFN 33	12	-	-	-	-	8+0.3/-0.1	4±0.2	
SOT-89 / SOT-89-5L	12	-	-	-	-	12±0.3	8	
TSSOP-8	12	-	-	-	-	-	-	
SOP-8	12	-	-	-	-	12±0.3	8±0.1	
MSOP-8	12	-	-	-	-	-	-	
SOT-223	12	-	-	-	-	16±0.3	8±0.1	
SOP-14 /SOP-16	16	-	-	-	-	16±0.3	8±0.1	
TO-252	16	-	-	-	-	16±0.3	8±0.1	
TO-263 /TO-263-5L	24	-	-	-	-	24±0.3	16±0.1	
Mini-MELF	8	3.73±0.05	1.1±0.05	3.5±0.05	1.8±0.05	8±0.05	4±0.1	
Mini-MELF	12	5.3±0.1	1±0.1	5.5±0.1	3±0.1	3±0.1	4±0.1	
MELF	12	8.2	1.5	5.5±0.05	3	12+0.3,-0.1	4±0.1	
SOD-523F	8	1.99	0.45	3.5±0.05	0.83	7.90~8.05	2.00±0.10	Note 1
SOD-723F	8	1.6	0.45	3.5±0.05	0.63	7.90~8.05	2.00±0.05	Note 1
DFN1006 (0402)	8	1.2	0.35	3.5±0.05	0.6	8.00+0.3/-0.1	2.00±0.05	Note 1
DFN1006L	8	1.24	0.4	3.5±0.05	0.6	8.00+/-0.1	2.00±0.10	Note 1